

"SAND-SET" COBBLESTONE PAVERS

#CSP-66

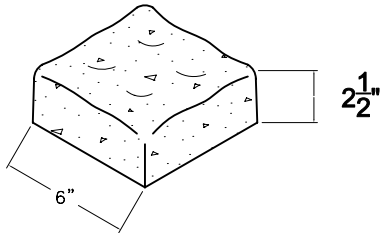

#CSP-612

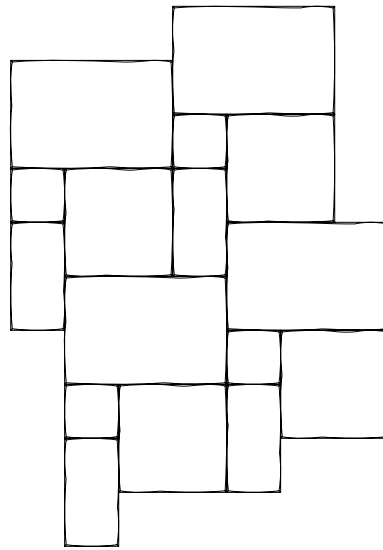
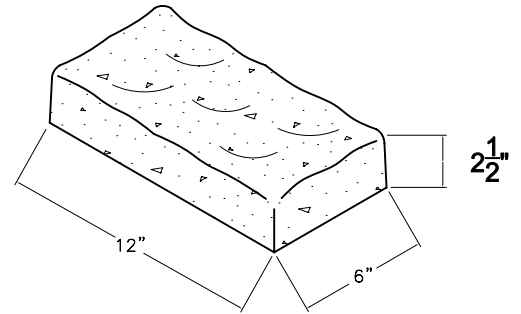

STANDARD PATTERN *

#CSP-1212

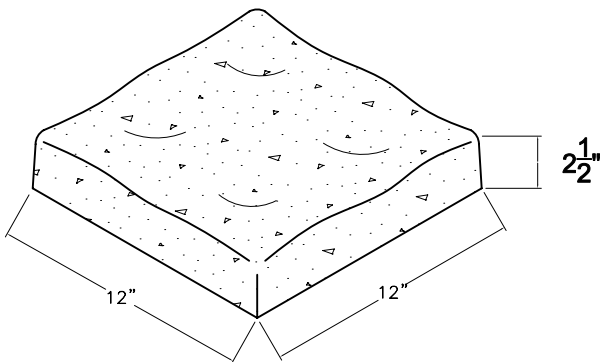

#CSP-1218

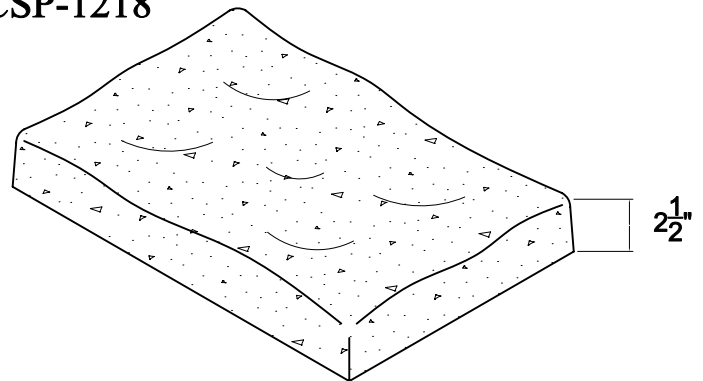

AVAILABLE IN THREE DISTINCTIVE COLOR BLENDS:
DESERT BROWN (COLORS P-1, P-3, P-5, P-7)
EUROPEAN GRAY (COLORS P-9, P-11, P-13, P-3)
RED ROCKS (COLORS P-5, P-15, P-17, P-19)

*CUSTOM COLORS AND PATTERNS AVAILABLE UPON REQUEST

RECOMMENDED FOR DRIVEWAY AND PARKING AREAS

COLOR VARIATIONS AND VARIEGATION ARE INHERENT IN THIS PRODUCT

SAND SET PAVERS

#SSP-99

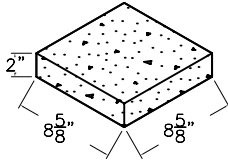

#SSP-1212

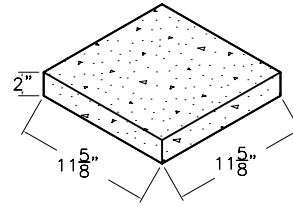

#SSP-918

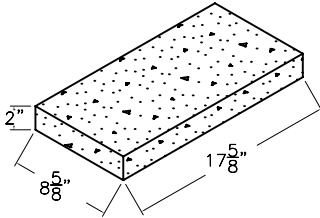

#SSP-1224

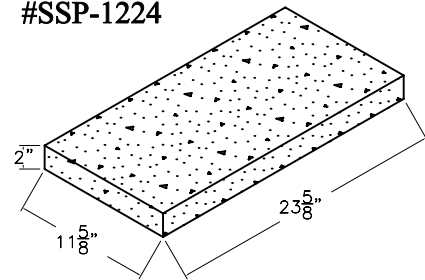

#SSP-1818

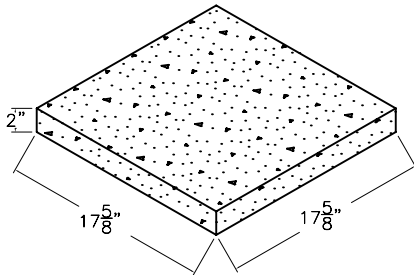

#SSP-2424

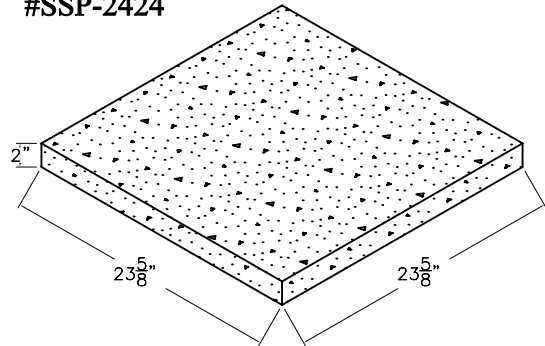

#SSP-1827

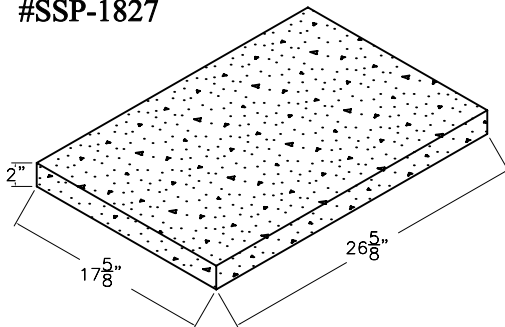

(SEE DECK TILE PATTERNS)
NOT RECOMMENDED FOR DRIVEWAYS AND PARKING AREAS

STEPPING STONES

#SS-1818

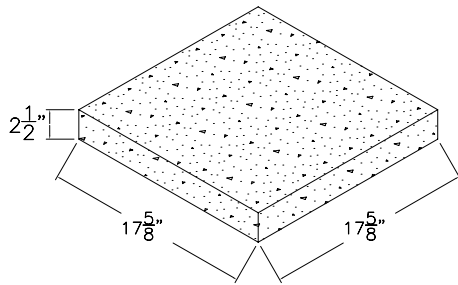

#SS-2424

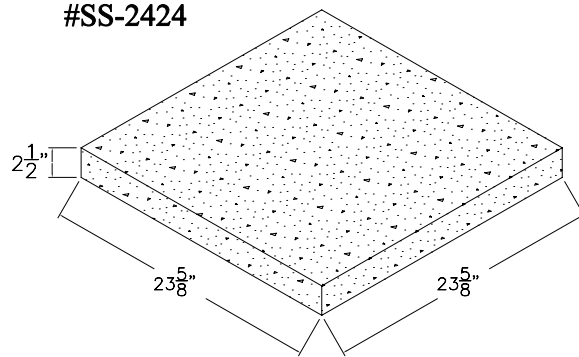

#SS-1827

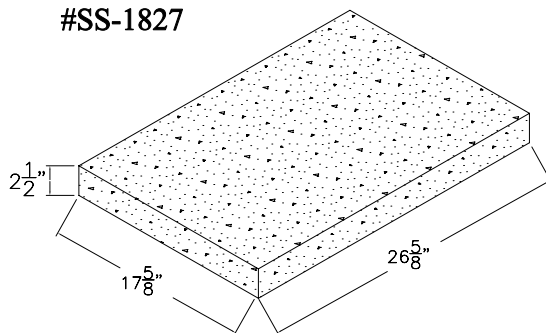

NOT RECOMMENDED FOR DRIVEWAYS AND PARKING AREAS

PRACTICAL PAVERS

**DC-1414
POOL COPING**

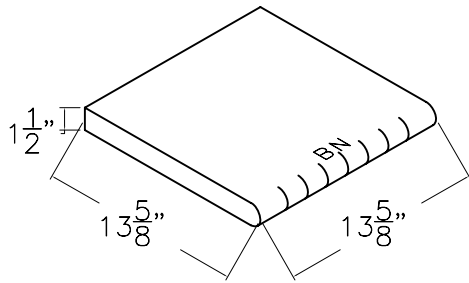

**EF-414
EDGE FACING**

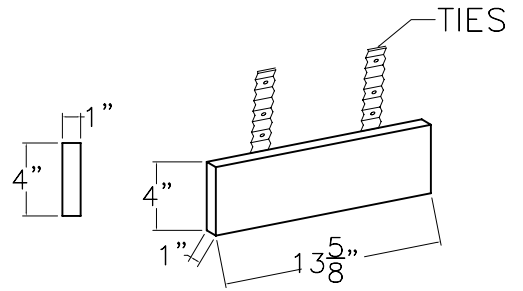

**DT-1414
PAVER**

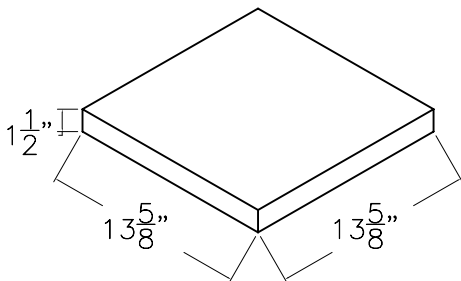

**DT-714
PAVER**

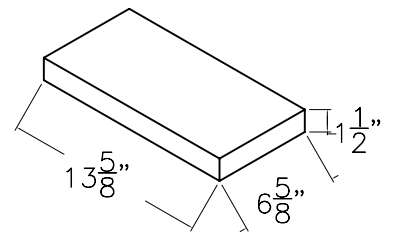

**DT-77
PAVER**

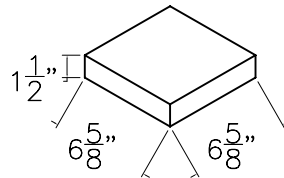

AVAILABLE IN FOUR DISTINCTIVE COLORS:
P-3 SAND, P-5 SUNSET, P-7 CARMEL, AND P-19 TERRA

PRACTICAL PAVERS

VARIOUS INSTALLATION CONFIGURATIONS

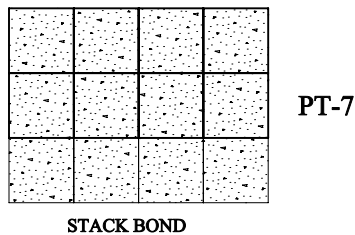
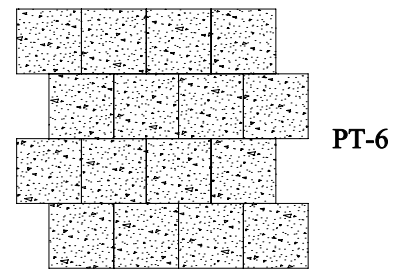
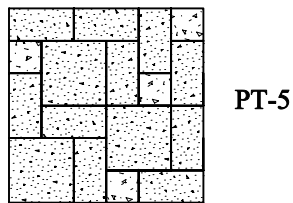
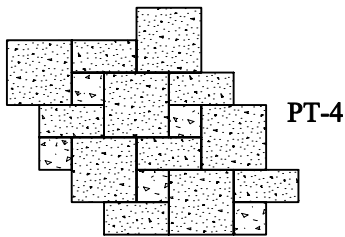
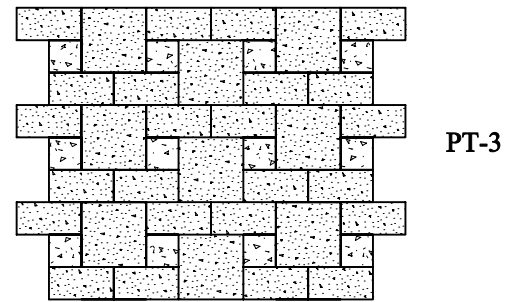
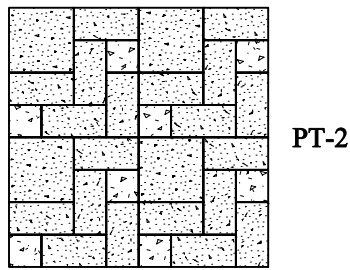
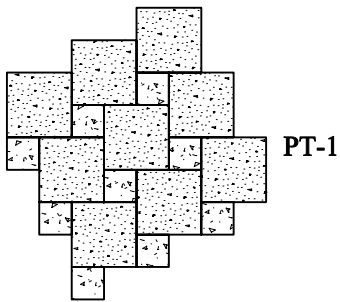

RUNNING BOND

STACK BOND

